

PLAN
 1:100

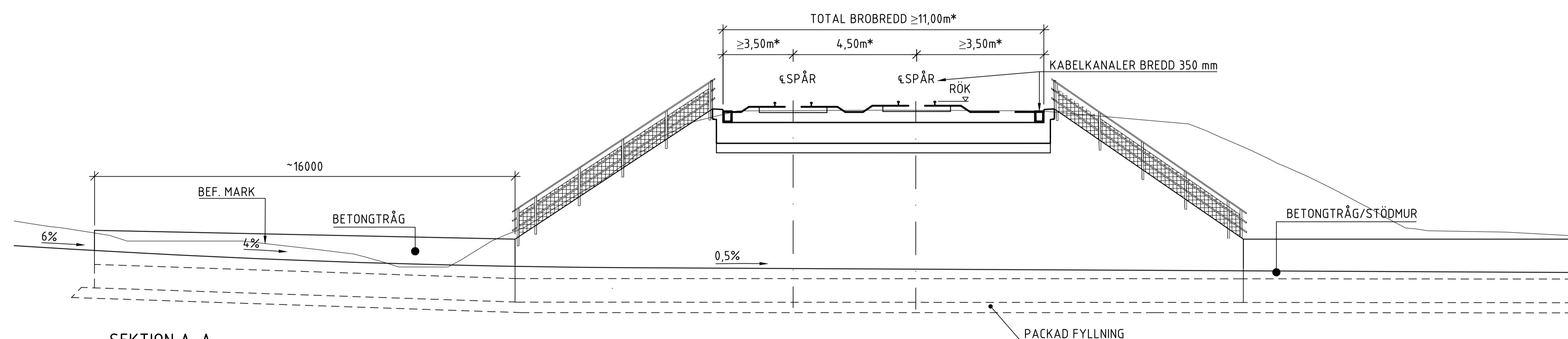

SEKTION A-A
 1:100

× MÅTT VINKELRÄTT KANTBALK ÖVERBYGGNAD

SEKTION	X	Y	ANM.
0/048,582	6424399,864	183620,312	R=400
0/073,432	6424385,097	183640,294	RL
0/164,750	6424328,570	183712,013	R=300
0/182,432	6424318,040	183726,215	

PLANDATA
 VÄG

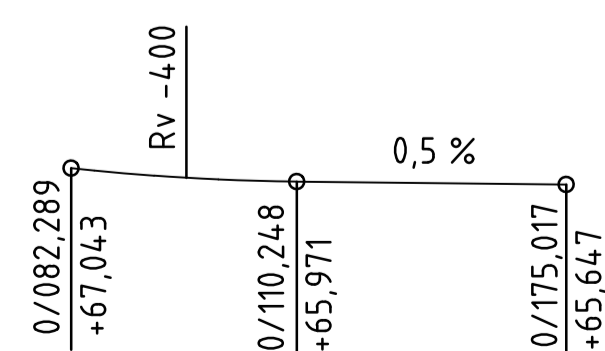

VÄGPROFIL
 VÄG

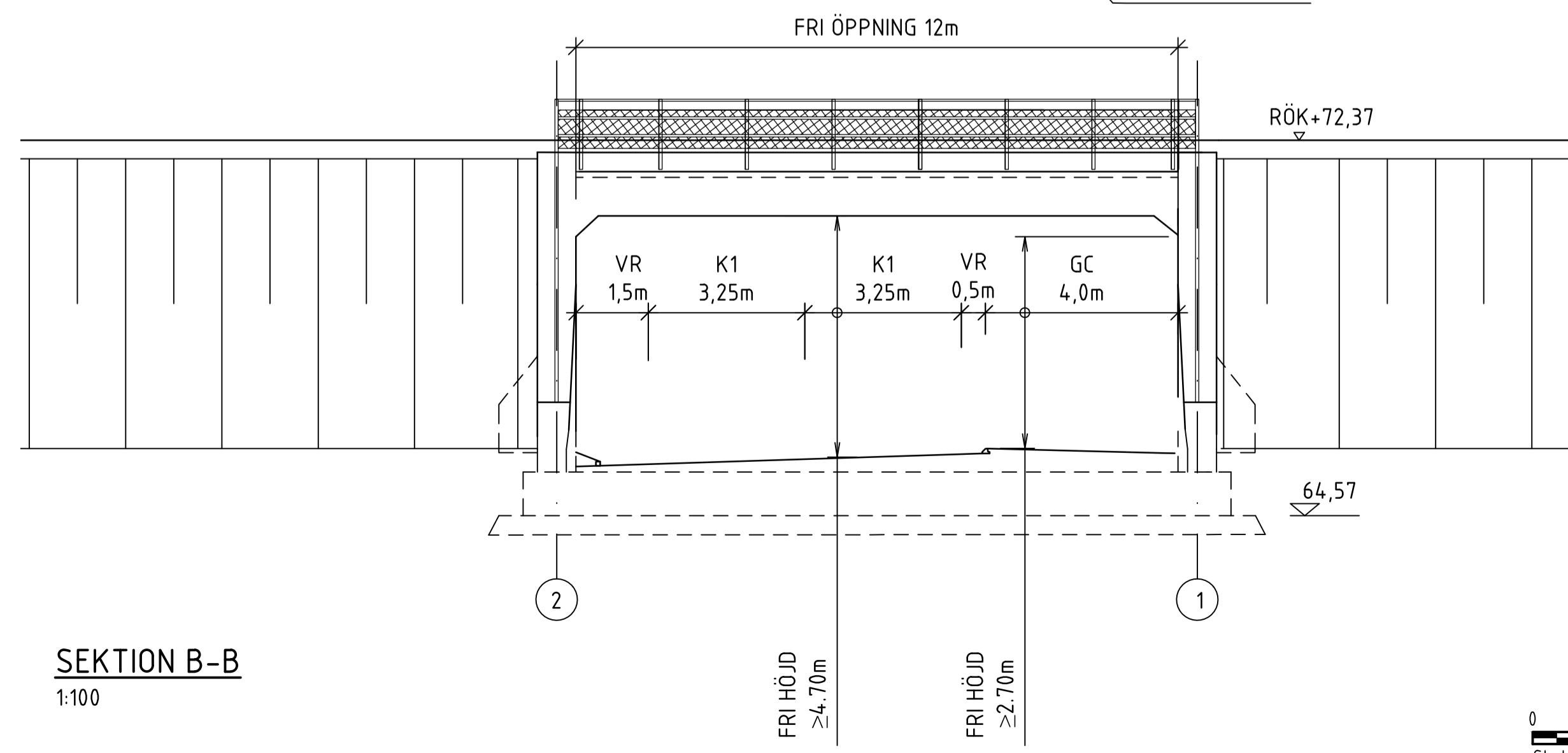

SEKTION B-B
 1:100

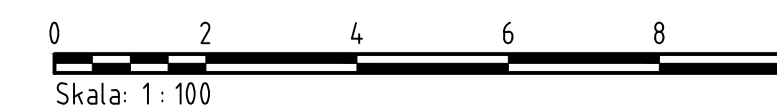

BET	ANDRINGEN AVSER	DATUM	SIGN

SKISS

ALINGSÅS
 JÄRNVÄGSUNDERFART



UPPDRAG NR	RITAD/KONSTR AV
-	R. JIGFELT
DATUM	HANDLAGGARE
2022-02-16	R. JIGFELT
ANSVARIG	
L. LUNDBERG	

SKALA	NUMMER	BET
1:200 1:100	BILAGA 1	

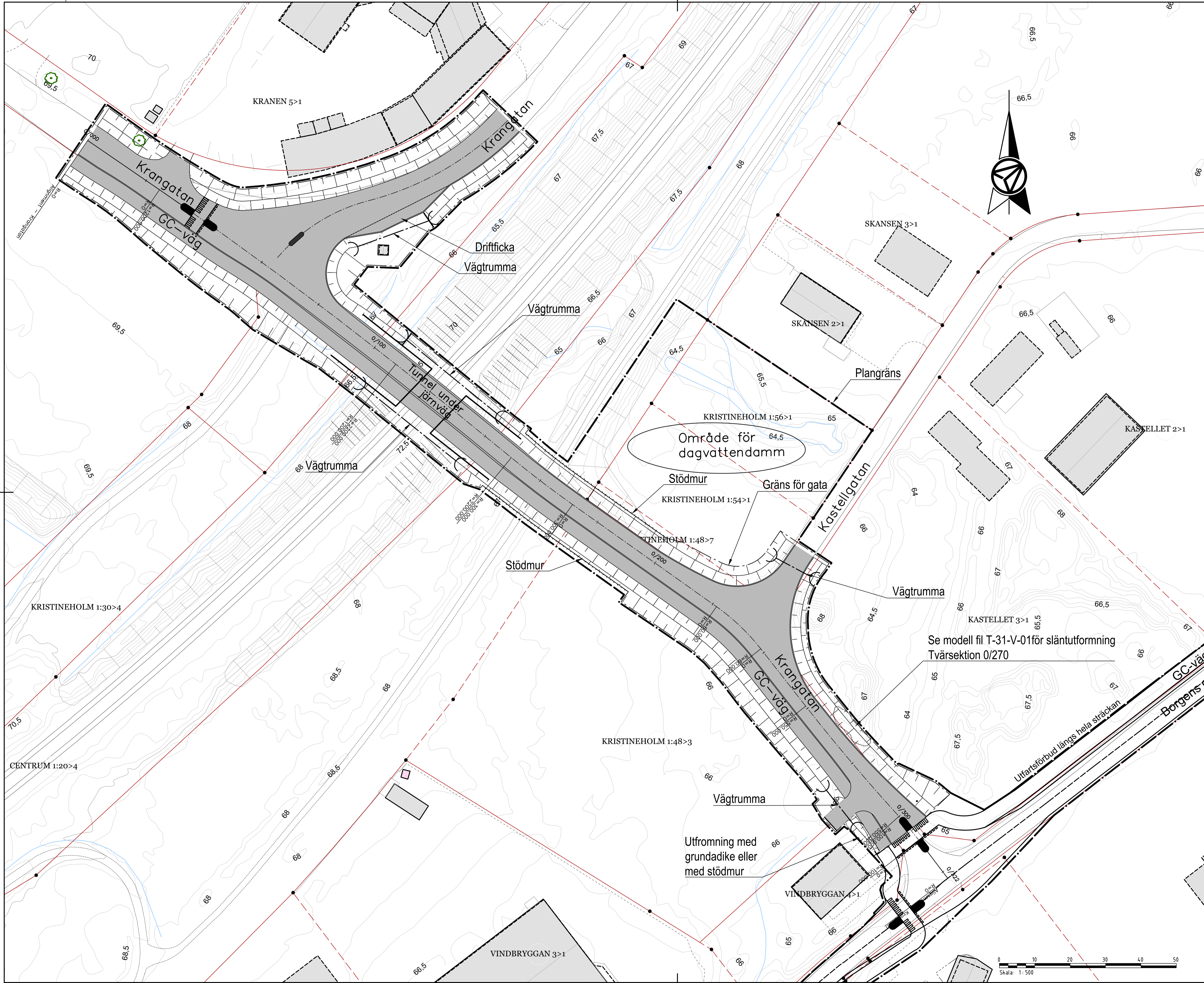

Se modell fil T-31-V-01 för slantutformning
Tvärsnitt 0/270

BET	ÄNDRINGEN AVSER	DATUM	SIGN
<p>GROV PROJEKTERING</p> <p>ALINGSÅS KOMMUN</p>			
<p>AFRY AF PÖRVA</p>			
UPPDRAG NR 200373	RITAD/KONSTR AV Rashid Kherfan	HANDLAGGARE Mattias Carlsson	
DATUM 2022-02-16	ANSVARIG Helen Ashman		
<p>Underfart vid Krangatan Plan</p>			
SKALA A1 - 1:500	NUMMER T-31-1-01	BET	

PRINCIPUTFORMNING I SKÄRNING MED SJÄLVFALL DIKE OCH STÖDMUR VID SEKTION 0/170

PLANGRÄNS

GRÄNS FÖR GATA

Säkerhetszon 3,90m SR 0,25m VR 0,25m Körbana 6,5m VR 0,25m GC-bana 3,75m SR 0,25m Säkerhetszon 3,6m

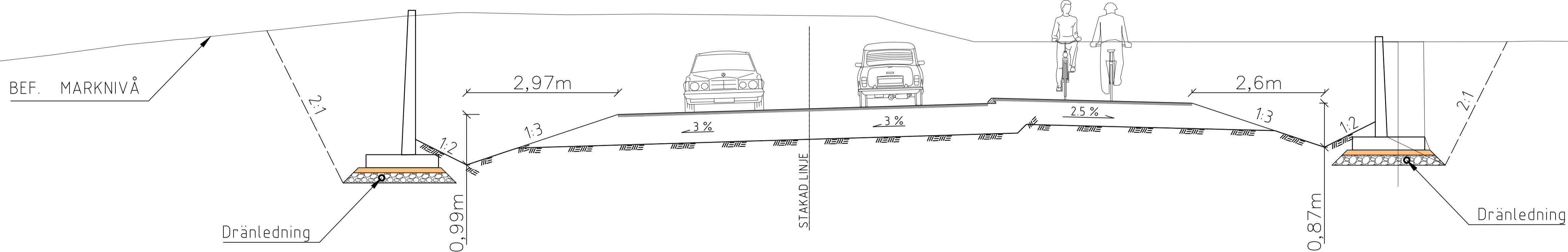

PRINCIPUTFORMNING I SKÄRNING MED SJÄLVFALL DIKE VID SEKTION 0/250

PLANGRÄNS

Säkerhetszon 8,10m SR 0,25m VR 0,25m Körbana 6,5m VR 0,25m GC-rbana 3,75m SR 0,25m Säkerhetszon 7,03m

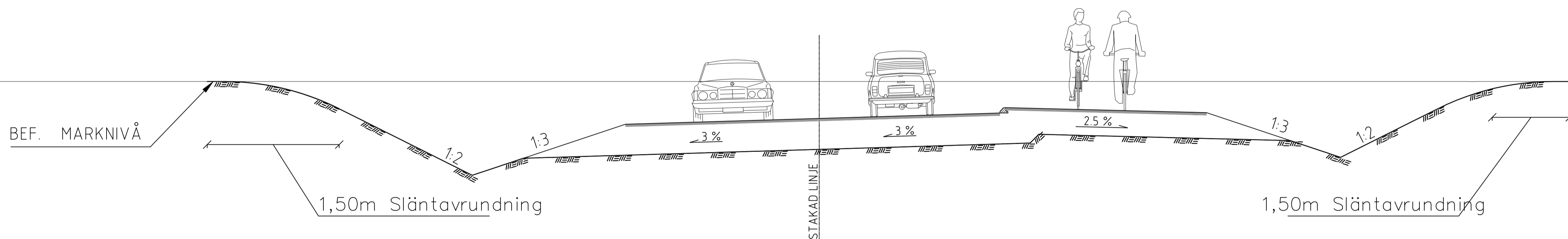

PRINCIPUTFORMNING I TUNNEL VID SEKTION 0/130

BEF. MARKNIVÅ

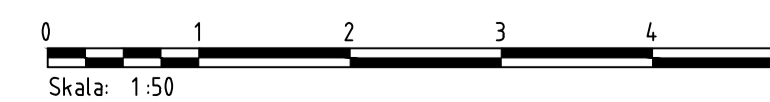
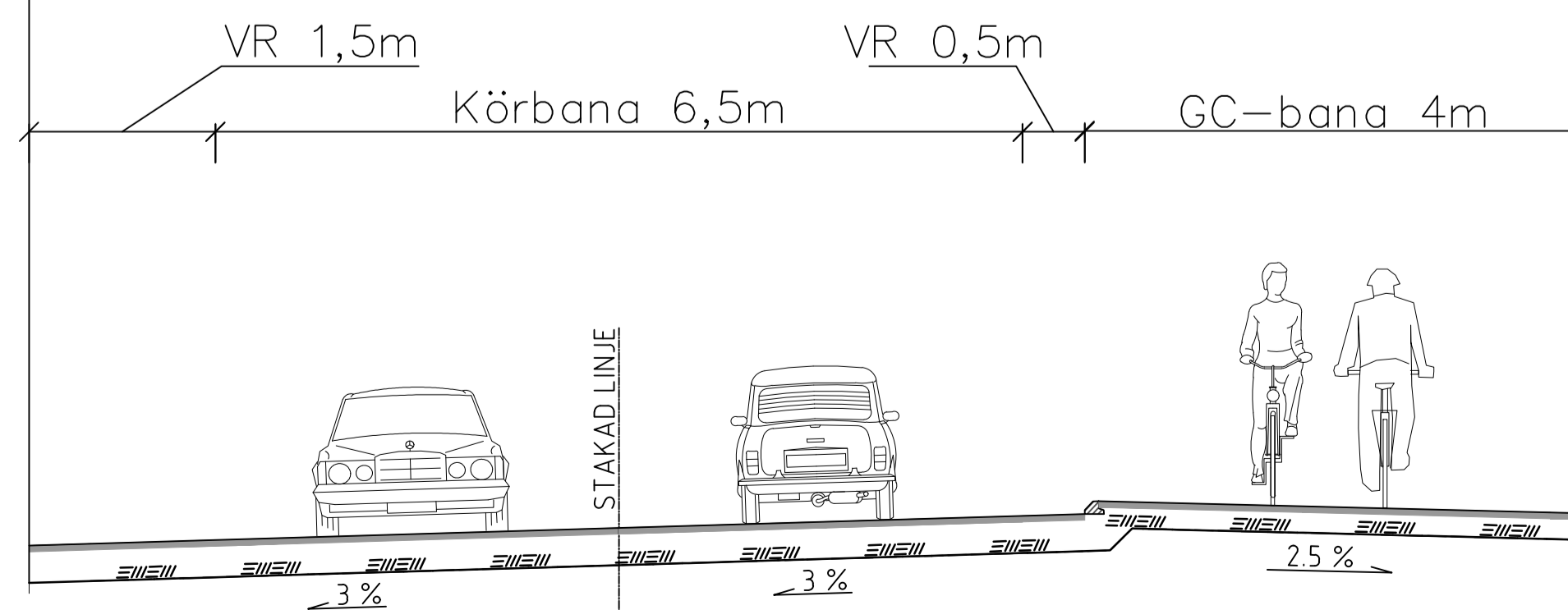

BET	ÄNDRINGEN AVSER	DATUM	SIGN
-----	-----------------	-------	------

GROV PROJEKTERING



UPPDRAG NR 200373	RITAD/KONSTR AV Rashid Kherfan	HANDLAGGARE Mattias Carlsson
DATUM 2022-02-16	ANSVARIG Helen Ashman	

Underfart vid Krangatån
TYPSEKTIONER

SKALA A1 - 1:50	NUMMER T-31-2-01	BET
--------------------	---------------------	-----

PLÖ: 2022-02-16 13:28 X:\1-PRJANSKIZ200373 - DETALJPLAN FÖR ALINGSÅS UNDERFART VID KRANGATÅN FÖRLÄNGNING OCH GÅNG_ OCH CYKELVÄG VID BORGENS GATA 669380\02_CAD\1 ISKED. DELOMRÅDE\T-RITNING\T-31-2-01.DWG KHERFAN, RASHID

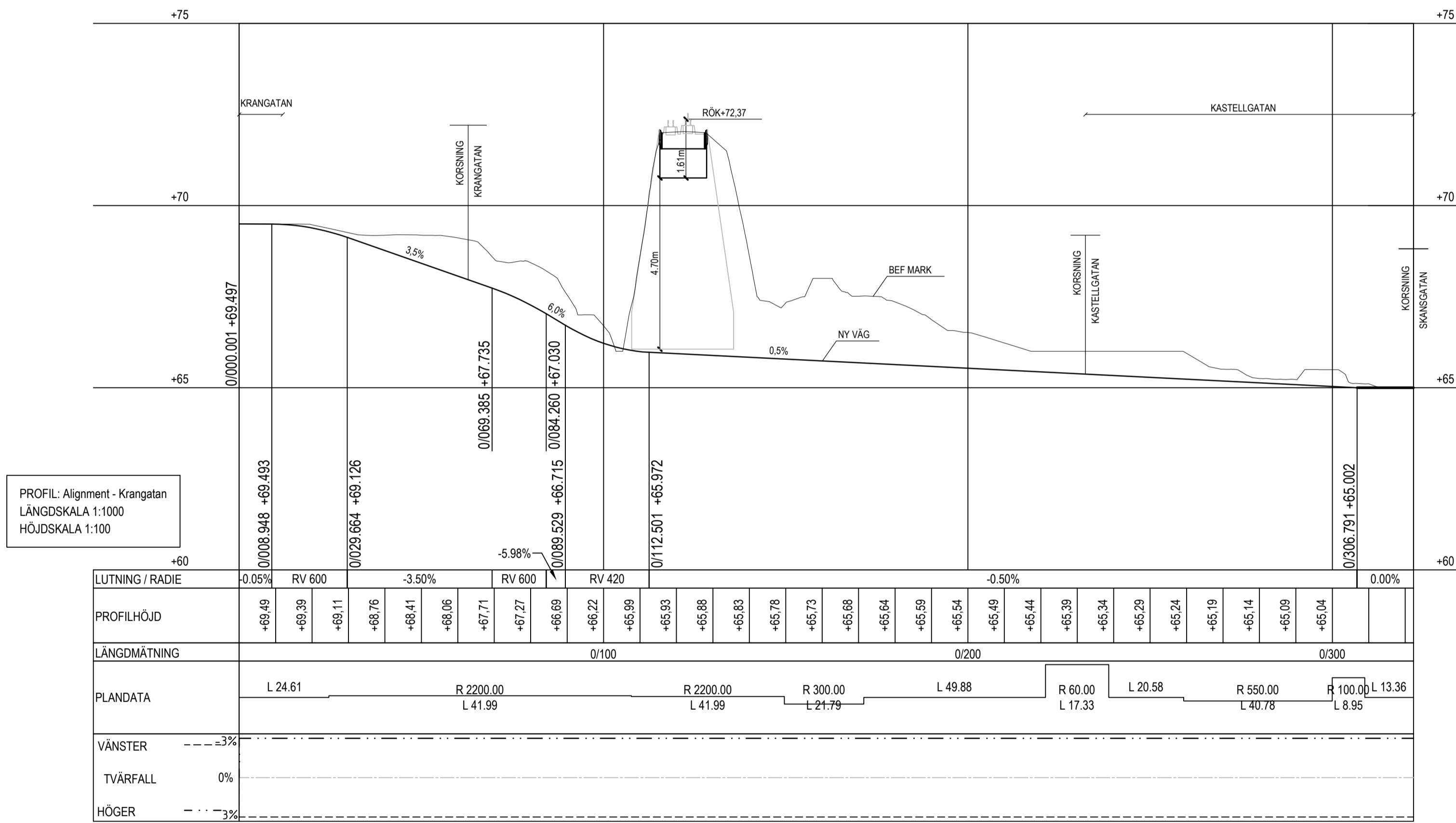

PROFIL: Alignment - Krangatan
LÄNGDSKALA 1:1000
HÖJDSKALA 1:100

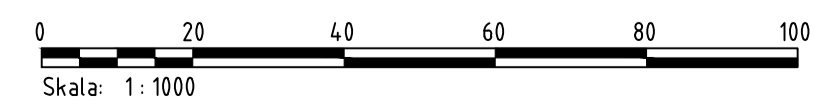

BET	ÄNDRINGEN AVSER	DATUM	SIGN
-----	-----------------	-------	------

GROV PROJEKTERING



UPPDRAG NR 200373	RITAD/KONSTR AV Rashid Kherfan	HANDLAGGARE Mattias Carlsson
DATUM 2022-02-16	ANSVARIG Helen Ashman	

Underfart vid Krangatan
Profil

SKALA 1:1000/1:100	NUMMER T-31-2-02	BET
-----------------------	---------------------	-----